

**MOTOROLA SOLUTIONS**

**Compact Portable Digital Two Way Radio  
with Analog Capability**

# **EVX-S24**

## **OPERATING MANUAL**

IP67 Dust- and Waterproof

---

---

# CONTENTS

---

---

<b>Introduction</b> .....	<b>1</b>	<b>Operation</b> .....	<b>13</b>
<b>Class B Digital Device</b> .....	<b>2</b>	Preliminary Steps .....	13
<b>Important Safety Information</b> .....	<b>3</b>	Operation Quick Start.....	13
<b>Consignes de sécurité importantes</b> .....	<b>5</b>	Automatic Time-Out Timer.....	15
<b>Controls &amp; Connectors</b> .....	<b>7</b>	ARTS™ (Auto Range Transpond System) .....	16
<b>LCD Icon &amp; Indicators</b> .....	<b>8</b>	LOCK .....	16
<b>Before You Begin</b> .....	<b>9</b>	<b>Advanced Operation</b> .....	<b>17</b>
Battery Pack Installation .....	9	Programmable Key Functions .....	17
Battery Pack Removal.....	9	Description of Operating Functions .....	19
Belt Clip Installation .....	10	<b>User Set (Menu) Mode</b> .....	<b>31</b>
Antenna Installation .....	10	<b>Optional Accessories</b> .....	<b>39</b>
Battery Charging .....	11	<b>Warranty Policy</b> .....	<b>40</b>
Low Battery Indication.....	12		

## Congratulations!

You now have at your fingertips a valuable communications tool, a Motorola Solutions two-way radio! Rugged, reliable and easy to use, your Motorola Solutions radio will keep you in constant touch with your colleagues for years to come, with negligible maintenance down-time. Please take a few minutes to read this manual carefully. The information presented here will allow you to derive maximum performance from your radio, in case questions arise later on.

### Important Note

- There are no owner-serviceable parts inside the radio. All service jobs must be referred to an authorized Motorola Solutions Service Representative.
- In order to maintain the specified water integrity performance, periodic maintenance is recommended.
- Should the radio sustain a severe shock (e.g. if it is dropped), the water integrity may be compromised, requiring service. Should this occur, contact your Authorized Motorola Solutions Dealer.

---

---

## INTRODUCTION

---

---

The **EVX-S24** is full-featured, compact Portable Digital/Analog Transceiver designed for business communications in the UHF Land Mobile band. The **EVX-S24** supports up to 256 user configurable channels within a maximum 16 groups, supporting a wide variety of business applications.

Channel frequency data for the transceiver is stored in flash memory, which is easily programmed by Motorola Solutions licensed dealers using a standard PC and the following Motorola Solutions programming equipment:

- CE157** PC Programming Software
- CB000262A01** Micro USB Programming Cable

This manual will describe in detail the many advanced features of the **EVX-S24**. After reading this manual, you may wish to consult with your Network Administrator regarding precise details of the configuration of this equipment for use in your application.

### **Important Notice for North American Users Regarding 406 MHz Guard Band**

The U.S. Coast Guard and National Oceanographic and Atmospheric Administration have requested the cooperation of the U.S. Federal Communications Commission in preserving the integrity of the protected frequency range 406.0 to 406.1 MHz, which is reserved for use by distress beacons. Do not attempt to program this apparatus, under any circumstances, for operation in the frequency range 406.0 - 406.1 MHz if the apparatus is to be used in or near North America.

Warning - Frequency band 406 - 406.1 MHz is reserved for use ONLY as a distress beacon by the US Coast Guard and NOAA. Under no circumstance should this frequency band be part of the pre programmed operating frequencies of this radio.

---

---

## CLASS B DIGITAL DEVICE

---

---

NOTE: This equipment has been tested and found to comply with the limits for a Class B digital device, pursuant to part 15 of the FCC Rules. These limits are designed to provide reasonable protection against harmful interference in a residential installation. This equipment generates uses and can radiate radio frequency energy and, if not installed and used in accordance with the instructions, may cause harmful interference to radio communications. However, there is no guarantee that interference will not occur in a particular installation. If this equipment does cause harmful interference to radio or television reception, which can be determined by turning the equipment off and on, the user is encouraged to try to correct the interference by one or more of the following measures:

- Reorient or relocate the receiving antenna.
- Increase the separation between the equipment and receiver.
- Connect the equipment into an outlet on a circuit different from that to which the receiver is connected.
- Consult the dealer or an experienced radio/TV technician for help.

---

---

## IMPORTANT SAFETY INFORMATION

---

---

### ENGLISH

### ATTENTION!

**This radio is restricted to Occupational use only.** Before using the radio, read the RF Energy Exposure and Product Safety Guide for Portable Two-Way Radios which contains important operating instructions for safe usage and RF energy awareness and control for Compliance with applicable standards and Regulations.

For a list of Motorola Solutions-approved antennas and other accessories, visit the following website:  
<http://www.motorolasolutions.com>

Any modification to this device, not expressly authorized by Motorola Solutions, may void the user's authority to operate this device.

Under Industry Canada regulations, this radio transmitter may only operate using an antenna of a type and maximum (or lesser) gain approved for the transmitter by Industry Canada. To reduce potential radio interference to other users, the antenna type and its gain should be so chosen that the equivalent isotropically radiated power (e.i.r.p.) is not more than that necessary for successful communication.

This radio transmitter has been approved by Industry Canada to operate with Motorola Solutions-approved antenna with the maximum permissible gain and required antenna impedance for each antenna type indicated. Antenna types not included in this list, having a gain greater than the maximum gain indicated for that type, are strictly prohibited for use with this device.

---

---

## IMPORTANT SAFETY INFORMATION

---

---

### ENGLISH

### Notice to Users (FCC and Industry Canada)

This device complies with Part 15 of the FCC rules and Industry Canada's license-exempt RSS's per the following conditions:

- This device may not cause harmful interference.
- This device must accept any interference received, including interference that may cause undesired operation.
- Changes or modifications made to this device, not expressly approved by Motorola Solutions, could void the authority of the user to operate this equipment.

---

---

## CONSIGNES DE SÉCURITÉ IMPORTANTES

---

---

### FRENCH

### ATTENTION!

Cette radio ne doit être utilisée qu'à des fins professionnelles. Avant d'utiliser la radio, lisez le guide Radios bidirectionnelles portatives : exposition aux radiofréquences et sécurité du produit, qui contient d'importantes instructions de fonctionnement pour une utilisation sécuritaire et des informations sur l'exposition aux fréquences radioélectriques, dans le but d'assurer votre conformité aux normes et règlements en vigueur.

Visitez le site Web suivant pour obtenir la liste des antennes et autres accessoires approuvés par Motorola Solutions:  
<http://www.motorolasolutions.com>

Toute modification effectuée à cet appareil sans l'autorisation explicite de Motorola Solutions peut annuler l'autorisation d'utiliser cet appareil.

Selon la réglementation d'Industrie Canada, cet émetteur radio ne peut être utilisé qu'avec une antenne dont le type et le gain maximal (ou minimal) sont approuvés par

Industrie Canada pour cet émetteur. Afin de limiter les interférences radio pour les autres utilisateurs, le type et le gain de l'antenne doivent être choisis de façon à ce que la puissance isotrope rayonnée équivalente (P.I.R.E.) ne soit pas plus forte qu'il ne le faut pour établir la communication.

Cet émetteur radio a été approuvé par Industrie Canada pour utilisation avec une antenne approuvée par Motorola Solutions offrant le gain maximal autorisé et l'impédance requise pour le type d'antenne indiqué. Il est strictement interdit d'utiliser avec cet appareil tout type d'antenne ne figurant pas dans cette liste et présentant un gain supérieur au maximum indiqué pour le type.

---

---

## CONSIGNES DE SÉCURITÉ IMPORTANTES

---

---

### **FRENCH**

### **Avis aux utilisateurs (FCC et Industrie Canada)**

Le présent appareil est conforme aux CNR d'Industrie Canada applicables aux appareils radio exempts de licence et à la partie 15 des règlements de la FCC.

- Cet appareil ne doit pas causer d'interférence nuisible.
- Cet appareil doit accepter toute interférence reçue, y compris les interférences pouvant entraîner un fonctionnement indésirable.
- Toute modification effectuée à cet appareil sans l'autorisation explicite de Motorola Solutions peut annuler l'autorisation d'utiliser cet appareil.



# CONTROLS & CONNECTORS

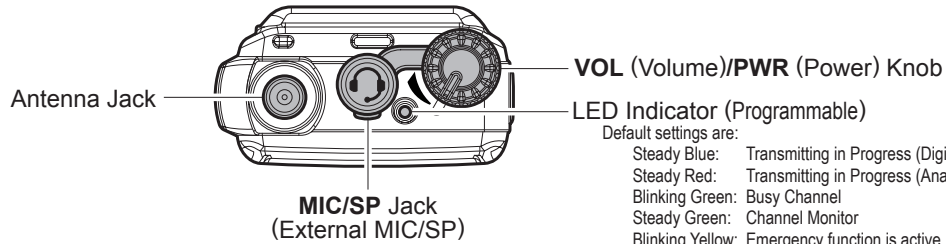

Default settings are:

- Steady Blue: Transmitting in Progress (Digital)
- Steady Red: Transmitting in Progress (Analog)
- Blinking Green: Busy Channel
- Steady Green: Channel Monitor
- Blinking Yellow: Emergency function is active
- Blinking Red: Low Battery Power

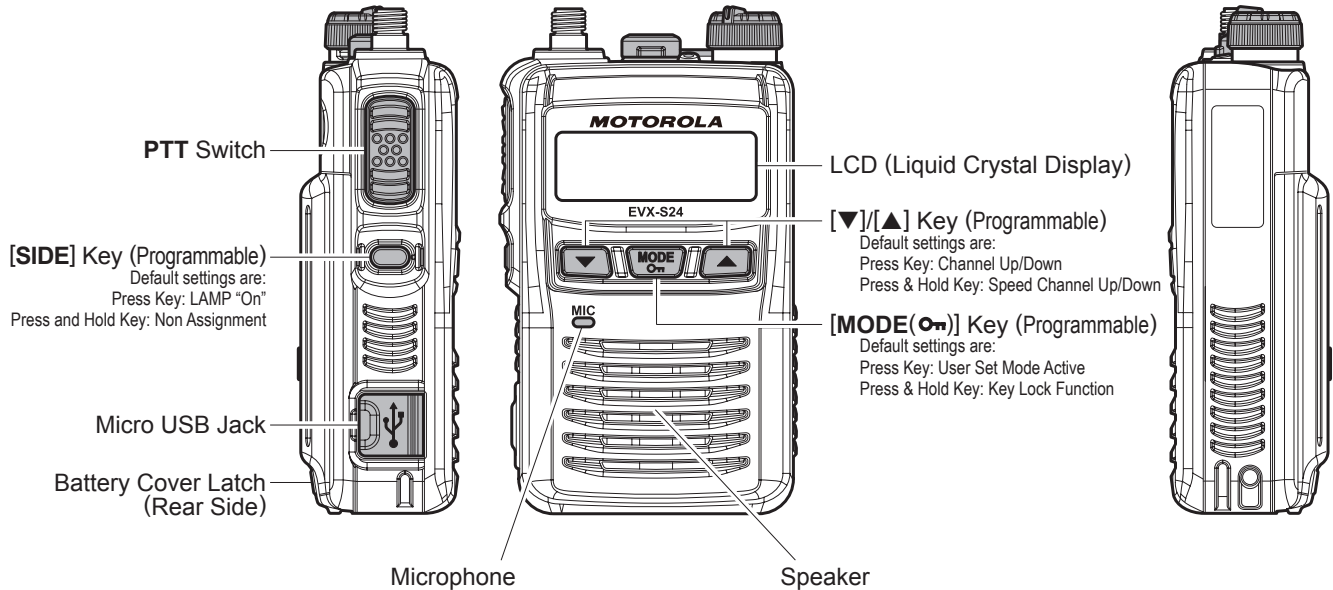

# LCD ICON & INDICATORS

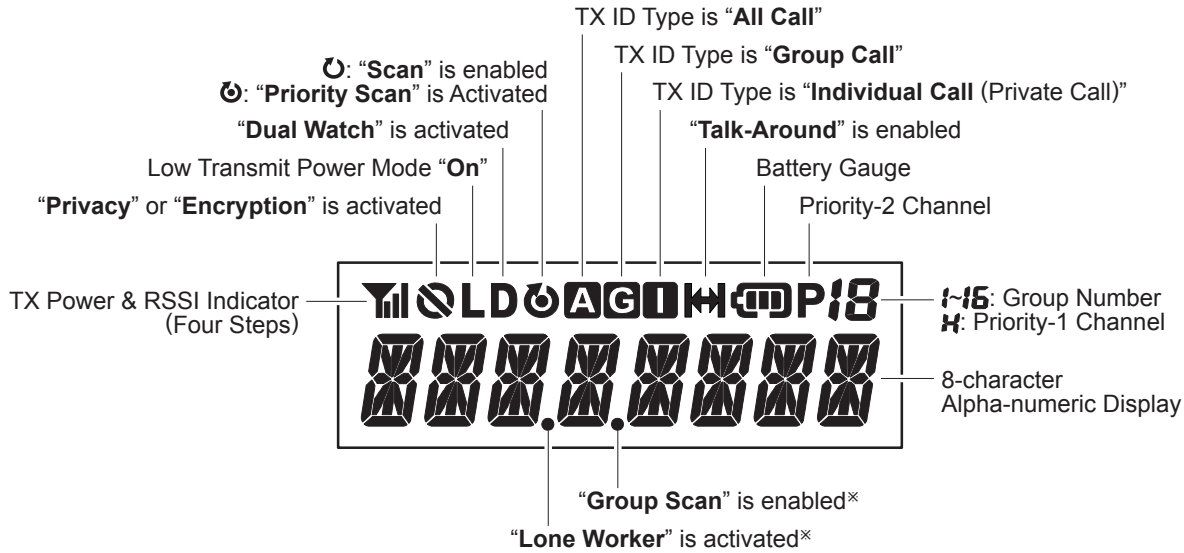

※ These small dot indication will appear continuously until deactivated, regardless of the operation status of other active features. For example, the LCD pictured to the right shows an active emergency feature, which continues to be visible even during an emergency call, when activated on the radio.



"Lone Worker" is activated

BATTERY GAUGE	
	: Full Battery Power
	: Moderate Battery Power
	: Low Battery Power
	: Poor Battery Power (Charge the Battery)

## BEFORE YOU BEGIN

### Battery Pack Installation

1. Make sure that the **VOL/PWR** knob powered off, by turning the knob counter clockwise to a complete stop.
2. Slide the Battery Cover Latch into the “UNLOCK” position, then remove the Battery Cover.
3. Install the **BT100X** Battery Pack into the battery compartment of the transceiver.
4. Re-attach the battery cover by aligning the tabs of the battery cover with the slots on the transceiver and sliding into position.
5. Slide the Battery Cover Latch into the “LOCK” position.

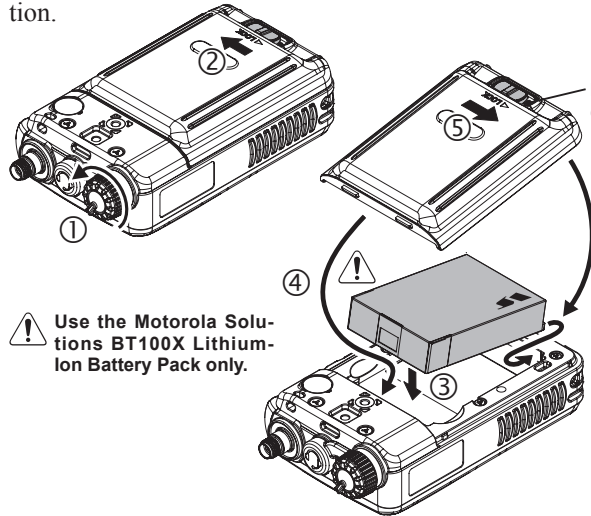

⚠ Use the Motorola Solutions BT100X Lithium-Ion Battery Pack only.

### Battery Pack Removal

1. Turn the radio off and remove any protective cases.
2. Slide the Battery Cover Latch into the “UNLOCK” side, then remove the Battery Cover.
3. Pinch the top side of the Battery Pack, then pull out the Battery Pack.

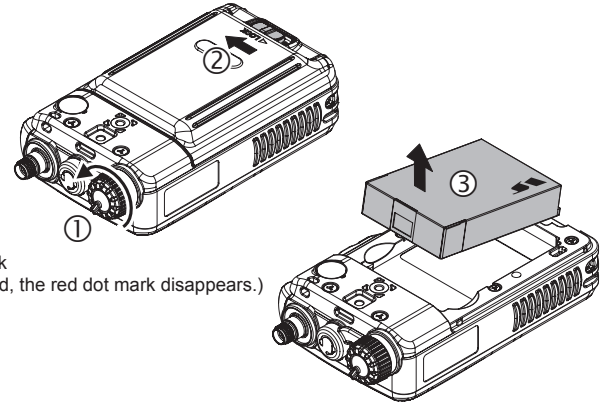

#### ⚠ CAUTION ⚠

- ❑ Risk of explosion if battery is replaced by an incorrect type. Dispose of used batteries according to the instructions.
- ❑ Do not attempt to open any of the rechargeable Lithium-Ion packs, as they could explode if accidentally short-circuited.

---

## BEFORE YOU BEGIN

---

### Belt Clip Installation

Align the tab in the upper side of the Belt Clip to the slot on the transceiver, and then secure the Belt Clip by tightening the belt clip screw to the radio chassis with a Phillips head screwdriver.

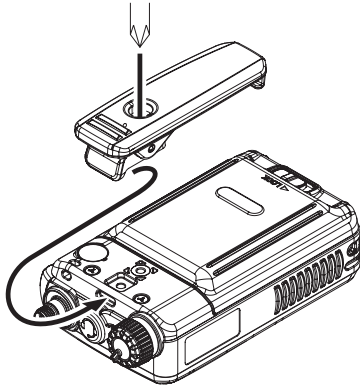

### Antenna Installation

Hold the bottom end of the antenna, then screw it onto the mating connector on the transceiver until snug. Do not over-tighten with extreme force.



**Never transmit without having an antenna connected.**

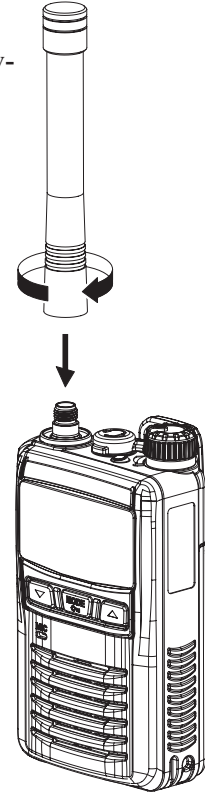

---

## BEFORE YOU BEGIN

---

### Battery Charging

- ❑ Turn the transceiver off.
- ❑ Open the Rubber Cover of the USB Jack.
- ❑ Insert the Micro USB plug from the optional Power Supply Adapter into the Micro USB jack on the transceiver, and then connect the Power Supply Adapter to the AC line outlet.
- ❑ If the battery pack is installed correctly, the LED indicator on the top of the transceiver will glow red and the charging starts. A fully-discharged battery pack will charge completely in 1.5 - 4.5 hours.
- ❑ When charging is completed, the LED indicator will turn off.

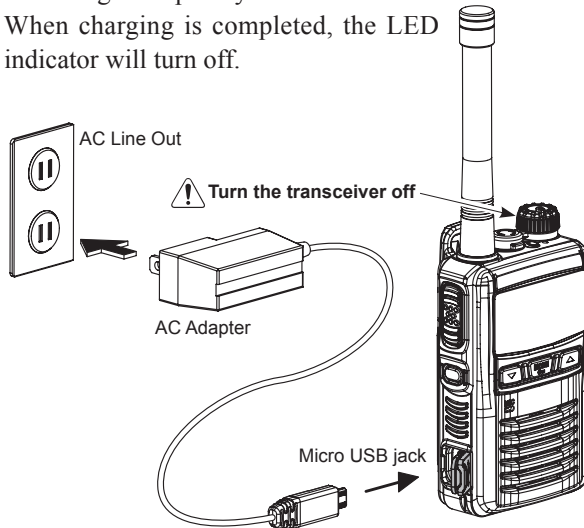

- ❑ Disconnect the Micro USB plug from the transceiver and close the Rubber Cover of the USB Jack.
- ❑ Unplug the Power Supply Adapter from the AC line outlet.



- 1) **Turn the transceiver off, when charging the battery.**
- 2) **Always use the Motorola Solutions BT100X Lithium-Ion Battery Pack.**
- 3) **Batteries carry a risk of explosion if replaced by an incorrect type.**
- 4) **Use only the Motorola Solutions Power Supply Adapter, or Motorola Solutions approved Charger.**
- 5) **Do not connect the USB charger other than Power Supply Adapter, as cause to damage the battery and transceiver.**
- 6) **Motorola Solutions prohibits the battery charge with a combination of the common Micro USB cable and USB power supply.**
- 7) **To reduce the risk of explosion, recharge the batteries outside of hazardous locations.**
- 8) **Perform the battery charging where the ambient temperature range +41 °F to +104 °F (+5 °C to +40 °C). Charging outside of this temperature range could cause damage to the battery pack.**
- 9) **The Battery Pack should not be exposed to excessive**

---

---

## BEFORE YOU BEGIN

---

---

*heat such as sunshine, fire, or similar heat sources.*

*10) This transceiver does not keep the Dust- and Water-proof rating (IP67) when the Rubber Cover is not secured over the USB jack.*

### **Low Battery Indication**

As the battery discharges during use, the voltage gradually becomes lower. When the battery voltage becomes too low, substitute a freshly charged battery and recharge the depleted pack. The LED indicator on the top of the radio will blink red when the battery voltage is low.

You may confirm the battery condition by the Battery Gauge on the display. See page 8 for more information.

## OPERATION

### Preliminary Steps

- ❑ Install a battery pack into the transceiver and charge the battery fully, as described previously.
- ❑ Screw the supplied antenna onto the Antenna jack, as described previously.

It is not recommended to operate this transceiver without an antenna connected.

- ❑ If you have a Speaker/Microphone, we recommend that it not be connected until you are familiar with the basic operation of the **EVX-S24**. Refer to next page for more information about Speaker/Microphone usage.

#### IMPORTANT NOTE

The dust- and waterproof rating of the transceiver (IP67) is assured only when the following conditions are met:

- ❑ Battery Cover is attached to the transceiver;
- ❑ Antenna is connected to the antenna jack;
- ❑ Rubber Cover is installed over the **Micro USB** jack.
- ❑ **MIC/SP** cap is installed in the **MIC/SP** jack.  
Or the Speaker/Microphone that approved with an IP67 rating by Motorola Solutions is installed in the **MIC/SP** jack.

### Operation Quick Start

- ❑ Turn the top panel's **VOL/PWR** knob clockwise to turn on the radio.

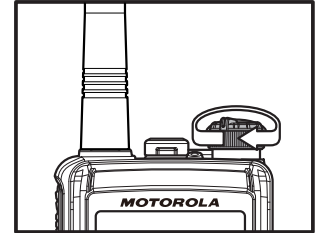

- ❑ Press the [▼]/[▲] key to choose the desired operating channel.

If you want to select the operating channel from a different Channel Group, press (or press and hold) the Programmable key (assigned to the “Group Up/Down” function) to change desired Channel Group before selecting the operating channel.

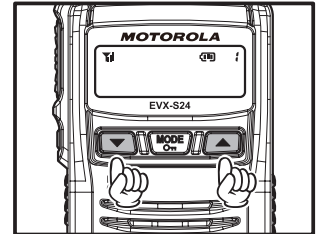

- ❑ Rotate the **VOL/PWR** knob to set the volume level.

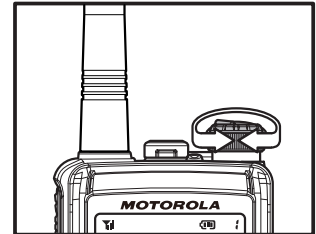

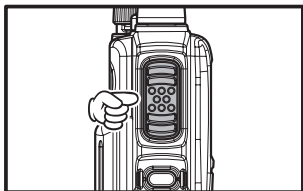

## OPERATION

- ❑ To transmit, press and hold in the **PTT** switch. Speak into the microphone area of the front panel grille in a normal voice level.



To return to the receive mode, release the **PTT** switch.

- ❑ Press the [**MODE**()] key to enter the User Set (Menu) Mode for activating the various functions: press the [▼]/[▲] key to select the desired function, and then press the [**MODE**()] key to initiate it.

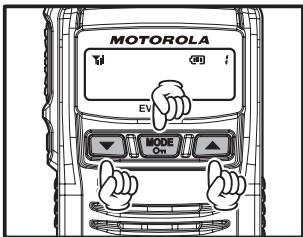

See page 31 for more information regarding the “User Set (Menu)” mode.

- ❑ To install a speaker microphone or other audio accessory, lift the rubber cap from the **MIC/SP** jack of the transceiver. Make sure that the transceiver is turned off, then insert the threaded microphone plug into the **MIC/SP** jack, and screw it into place until tight, being careful not to damage the Speaker/Microphone cable. Inserting the plug into the jack will disable the internal speaker. Hold the speaker grille up next to your ear while receiving. To transmit, press the **PTT** switch on the Speaker/Microphone, just as you would on the main transceiver’s body, and speak into the microphone on a normal voice level.

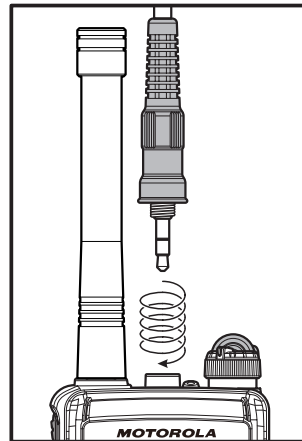

*Note 1) When you press the PTT switch on the Speaker/Microphone, it disables the internal microphone, and vice versa.*

*2) To keep the Dust- and Waterproof (IP67), the rubber cap should be reinstalled to the MIC/SP jack when not using the Speaker/Microphone.*



---

## OPERATION

---

- ❑ The **EVX-S24** has two modes of DMR operation to maximize spectrum efficiency. Standard operation requires use of a TDMA repeater (such as the **EVX-R70**) to utilize the repeater's dual time slot capability for doubling your radio fleet's communication paths for up to two simultaneous transmissions. The second mode is **Direct mode**, which enables two communications paths on a single frequency, doubling your capacity with only the subscriber radios. No repeater is necessary when operating in Direct mode.
- ❑ If the BCLO (Busy Channel Lockout) feature has been programmed on the channel, the radio will not transmit when a carrier is present. Instead, the radio will generate short beep three times. Release the **PTT** switch and wait for the channel to be clear of activity.
- ❑ If the BTLO (Busy Tone Lockout) feature has been programmed on an **analog channel**, the radio can transmit only when there is no carrier being received or when the carrier being received includes the correct tone (CTCSS tone or DCS code) on an **analog channel**.
- ❑ If the CCLO (Color Code Lockout) feature has been programmed on a **digital channel**, the radio can transmit only when there is no carrier being received or when the carrier being received includes a different code that you have set on a **digital channel**.

- ❑ Turn the **VOL/PWR** knob fully counter clockwise to turn off the radio.

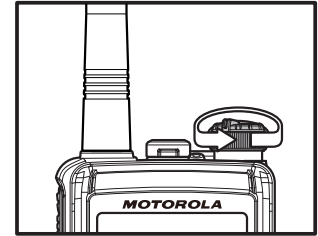

### Automatic Time-Out Timer

If the selected channel has been programmed with an Automatic Time-Out Timer, any transmission is limited to a fixed transmit time, dictated when programming the radio with CE157 software. A ten second warning tone/beep will sound before Automatic Time Out Timer is expired, with a second tone/beep sounding when the radio officially reaches the pre-set maximum transmission time. In addition, the top panel red LED (“**TX**” indicator) light will turn off and any transmission activity will stop. To resume transmission, the user must release the **PTT** switch and await expiration of the “penalty timer”.

---

---

## OPERATION

---

---

### **ARTS™** (Auto Range Transpond System)

This system is designed to inform the operator when you and another ARTS™-equipped transceivers and stations are within communication range using the DCS Encoder/Decoder.

During ARTS™ operation, when the radio receives an incoming ARTS™ signal, a short beep will sound twice and “**IN SERV**” (“In Service”) will be indicated on the display for 2 seconds. If you move out of range for more than two minutes, your radio senses that no signal has been received, causing a short triple beep to sound and “**OUT SERV**” (“Out of Service”) will be indicated on the display for 2 seconds. Moving back into communications range as the ARTS™ signal transmission from another transceiver or station is back in range, a short beep will sound twice again and “**IN SERV**” (“In Service”) will be indicated on the display for 2 seconds.

### **LOCK**

In order to prevent accidental channel changes or inadvertent transmissions, various aspects of the Programmable keys and **PTT** switch may be locked.

To activate the locking feature, press and hold the [**MODE**(**Om**)] key.

To cancel the key locking, press and hold the [**MODE**(**Om**)] key again.

You may change the lockout configuration by the “User Set (Menu)” mode. See page 36 for more information.

---

## ADVANCED OPERATION

---

### Programmable Key Functions

The **EVX-S24** provides four Programmable Function (**PF**) keys: [▼], [**MODE** (◀▶)], [▲] and [**SIDE**] keys.

These **PF** keys can be customized, via programming by your Motorola Solutions dealer, to meet your communications/network requirements.

The possible **PF** key programming features are illustrated on the next page, and their functions are explained from page 19. All functions can be assigned to any **PF** Key. Up to two functions can be assigned per key, with the feature being activated by:

- Short Press (SP) - Press and release
- Long Press (LP) - Press and hold

If further details are required, contact your Motorola Solutions dealer.

In this chapter, the following icons are used to indicate features supported in either the “Analog” mode or “Digital” mode:

: Indicates an “Analog” mode only feature.

: Indicates a “Digital” mode only feature.

For features that are available in both “Analog” and “Digital” modes, no icon is shown.

For future reference, the table on the right side of the page can be used to track each function assigned to the Programmable Function Keys on your radio.

## ADVANCED OPERATION

FUNCTION	PROGRAMMABLE KEY (PRESS KEY / PRESS AND HOLD KEY)			
	[SIDE]	[▼]	[MODE]	[▲]
None	/	/	/	/
Monitor	/	/	/	/
Lamp	/	/	/	/
Low Power	/	/	/	/
Privacy/Encryption	/	/	/	/
Privacy Set	/	/	/	/
SET	/	/	/	/
SQL OFF	/	/	/	/
SQL Set	/	/	/	/
Beep OFF	/	/	/	/
AF Min Volume	/	/	/	/
Whisper	/	/	/	/
VOX	/	/	/	/
VOX Set	/	/	/	/
VOX Anti-Trip	/	/	/	/
Emergency*1	/-	/-	/-	/-
Lone Worker	/	/	/	/
Group Up	/	/	/	/
Group Down	/	/	/	/
CH Up	/	/	/	/
CH Down	/	/	/	/
Speed CH Up*2	-/	-/	-/	-/
Speed CH Down*2	-/	-/	-/	-/
PRI-1	/	/	/	/
PRI-2	/	/	/	/
PRI-2 Set	/	/	/	/
PRI-2 Disable	/	/	/	/

FUNCTION	PROGRAMMABLE KEY (PRESS KEY / PRESS AND HOLD KEY)			
	[SIDE]	[▼]	[MODE]	[▲]
Scan	/	/	/	/
Group Scan	/	/	/	/
Dual Watch	/	/	/	/
Follow Me Scan	/	/	/	/
Scan Set	/	/	/	/
Group Scan Set	/	/	/	/
TA Scan	/	/	/	/
Talk Around	/	/	/	/
Search	/	/	/	/
Reset	/	/	/	/
Code Up	/	/	/	/
Code Down	/	/	/	/
Speed Dial	/	/	/	/
Call	/	/	/	/
Status Up	/	/	/	/
Status Down	/	/	/	/
Status Check	/	/	/	/
Duty	/	/	/	/
ID Check	/	/	/	/
Text Message	/	/	/	/
REMOTE HALT TX (TX Interrupt Remote Dekey)	/	/	/	/
TX Save Disable	/	/	/	/
Lock	/	/	/	/

\*1: Emergency function can not assign to the LP function.

\*2: Speed CH Up/Down functions can not assign to the SP function.

---

---

## ADVANCED OPERATION

---

---

### Description of Operating Functions

#### MONITOR

Any signaling features can be activated/deactivated by an assigned **PF** key. The LED indicator will glow green when the signaling feature is deactivated.

#### LAMP

Illuminates the back light of the display and keypad for five seconds.

#### LOW POWER

Toggle the radio's transmit power "High" and "Low". The battery life will be extended in the "Low Power" mode.

The "L" icon will be indicated on the display when the radio's transmitter is set to "Low Power" mode.

#### PRIVACY

Digital Privacy feature can be activated/deactivated by an assigned **PF** key. The Privacy feature initiates an encryption algorithm that will protect your communication from unauthorized eavesdropping.

The "🔒" icon will be indicated on the display when the Privacy feature is activated.



#### ENCRYPTION

Analog Voice Inversion Encryption can be activated/deactivated by an assigned **PF** key.

The "🔒" icon will be indicated on the display when the Encryption feature is activated.

#### PRIVACY SET

You can change the privacy settings to best meet your security requirements using this function:

- Activates the "Privacy Set" function by an assigned **PF** key. A tone will sound, and the "Tag" name corresponding with the current Privacy Code will appear on the display.
- Press the [▼]/[▲] keys to select the desired Privacy Code. Up to 16 Privacy Codes are available for selection.
- Press the [MODE()] key to store the new setting. The display indicates "- SET -" briefly, then reverts to the normal channel indication.  
You may cancel the new setting by press and holding the [MODE()] key. In this case, the display indicates "- CANCEL -" briefly.

---

## ADVANCED OPERATION

---

### SET



Activates the “User Set (Menu)” mode. See page 31 for more information of the “User Set (Menu)” mode.

### SQL OFF

SQL OFF opens the radio squelch/unmute the audio to hear background noise.

### SQL SET

You can manually adjust the squelch level using this function:

- Activates the “SQL Set” function by an assigned **PF** key. A tone will sound, and the current squelch level will appear on the display.
- Press the [▼]/[▲] keys to select the desired squelch level. Available selections are “**SQLLV OP** (Open)”, “**SQLLV TH** (Threshold)”, “**SQLLV NM** (Normal)” and “**SQLLV TI** (Tight)”.
- Press the [**MODE**()] key to store the new setting. The display indicates “- **SET** -” briefly, then reverts to the normal channel indication.  
You may cancel the new setting by press and holding the [**MODE**()] key. In this case, the display indicates “- **CANCEL** -” briefly.

### BEEP OFF

Activation of Beep off disables all radio beeps (alert tones) temporarily. Radio beeps will be restored by pressing the **PF** key again.

When the Beep Off function is “on” and “off”, the display indicates briefly “**BEEP OFF**” and “**BEEP ON**”.

### AF MIN VOLUME

Press the assigned **PF** key, the display indicates “**AFATT ON**” briefly, and reduce the audio output to the (lower) level programmed. Again press the assigned **PF** key, the display indicates “**AFATT OF**” briefly, and resume normal audio output level.

You may change the programmed (lower) level by the “User Set (Menu)” mode. See page 34 for more information.

### WHISPER

Whisper allows the user to increase the microphone gain, allowing the operator to speak in a low voice (whisper) temporarily when transmitting. The radio can go back to normal microphone gain by pressing the assigned **PF** key a second time.

When the Whisper function is “on” and “off”, the display indicates briefly “**WHISP ON**” and “**WHISP OF**”.

---

## ADVANCED OPERATION

---

### **VOX** (REQUIRES OPTIONAL VOX COMPATIBLE HEADSET)

Enabling the VOX function will allow hands free, automatic voice activation of the transmitter as the microphone picks up audio. The **PTT** switch does not need to be pressed to open the channel when VOX is enabled.

### **VOX SET**

You can manually adjust the VOX Gain using this function:

- Activates the “VOX Set” function by an assigned **PF** key. A tone will sound, and the current VOX Gain level will appear on the display.
- Press the [**▼**]/[**▲**] keys to select the desired VOX Gain level.
- Press the [**MODE**(**On**)] key to store the new setting. The display indicates “- **SAVED** -” briefly, then reverts to the normal channel indication. You may cancel the new setting by press and holding the [**MODE**(**On**)] key. In this case, the display indicates “- **CANCEL** -” briefly.

### **VOX ANTI-TRIP**

Toggle the VOX Anti-Trip function “On” and “Off”. VOX Anti-Trip prevents the transceiver from activating a VOX transmission from either internal or external radio alert tones (radio beeps).

### **EMERGENCY**

Emergency can either be programmed in analog or digital mode. When the Emergency key is pressed, activate the pre-programmed functions which is the LED indicator will illuminate yellow and the **EVX-S24** repeats the transmission and reception 3 times for 10 seconds. This operations can be customized in the CE157 software by your Motorola Solutions authorized dealer.

To revive the radio from the Emergency mode, just press again the assigned **PF** key or turn off the radio.

### **LONE WORKER**

Toggle the Lone Worker feature “On” and “Off”.

The Lone Worker feature is designed to emit an alarm for 30 seconds when the Lone Worker Timer (programmed by your Motorola Solutions dealer) has expired. If the user does not reset the timer by pressing the **PTT** switch, the radio switches to Emergency mode.

When the Lone Worker feature is activated, a small dot (“•”) will be indicated at the bottom of the display. When the Lone Worker feature is first activated, the display indicates “**L-WK ON**” and “**L-WK OFF**” briefly.

---

## ADVANCED OPERATION

---

### GROUP Up/DOWN

Select a different group of channels. A group number will appear at the upper right corner and a group name will appear briefly on the display.

### CH Up/DOWN

Select a different channel. A channel name will appear on the display.

### SPEED CH Up/DOWN

Press and holding the assigned **PF** key to begin stepping (repeatedly) upward or downward through the channels. When you release the **PF** key, the channel stepping will stop immediately.

### PRI-1

Recall the pre-programmed Priority Channel (Priority-1) by your Motorola Solutions dealer directly. When PRI-1 channel is recalled, the “**H**” icon will appear at the upper right corner of the display.

### PRI-2

Recall the pre-programmed Priority Channel of the current group (Priority-2) by your Motorola Solutions dealer directly. When PRI-2 channel is recalled, the “**P**” icon will appear on the display.

### PRI-2 SET

Toggle the current channel to the priority channel 2 “enable” and “disable”. When the current channel will be set to the PRI-2 channel, the display indicates the “**P**” icon briefly.

### PRI-2 DISABLE

Press the assigned **PF** key, the display indicates “**PRI2 DI**” briefly, and disable the priority channel 2 of the group temporarily.

Press again the assigned **PF** key, the display indicates “**PRI2 EN**” briefly, and enabling the priority channel 2 of the group.

### SCAN

Activates the Scanning feature which is used to monitor multiple channels programmed into the transceiver. When scanning, the transceiver will check each channel for the presence of a signal and will stop on a channel if a signal is present.

*Note:* Your dealer may have programmed your radio to stay on one of the following channels if you press the **PTT** switch during scanning pause:

- Current channel
- “Scan Pause” channel (“Talk Back”)
- “Last Busy” channel
- “Priority” channel (PRI-1 or PRI-2)
- “User Programmed” channel (“Select Channel”)



---

---

## ADVANCED OPERATION

---

---

### GROUP SCAN

The scanning feature is used to monitor multiple channels programmed into the transceiver. While scanning, the transceiver will check each channel of the programmed group for the presence of the signal, and will stop on a channel if a signal is present.

Press the assigned **PF** key to activate the scanning on the selected groups.

Press again the assigned **PF** key to disable the group scan mode, and receive the channel which was chosen when pressed the **PF** key.

When the Group Scan is activated, the display will indicate “**GRP SCAN**”, and current group channel number will appear at the upper right corner on the display.

### DUAL WATCH

The Dual Watch feature is similar to the SCAN feature, except that only two channels are monitored:

- The current operating channel
- The Priority channel (PRI-1 or PRI-2).

#### *To activate Dual Watch:*

- Press the assigned **PF** key to activate the Dual Watch feature.
- The scanner will search the two channels and pause when it finds a transmission on either channel.

#### *To stop Dual Watch:*

- Press the assigned **PF** key to disable the Dual Watch feature. The radio receives the current operating channel.

When the Dual Watch feature is activated, the “**D**” icon will be indicated on the display.

### FOLLOW ME SCAN

The Follow Me Scan feature checks an user-assigned priority channel in addition to the channels previously pre-programmed into a radio’s scan list. For example, if only Channels 1, 3, and 5 (of the 8 available channels) are designated for “Scanning”, the user may assign Channel 2 as the “user-assigned” priority channel via the Follow Me Scan.

To activate Follow Me Scan, first select the channel you want to designate as the “user-assigned priority channel” by pressing the [▼]/[▲] keys on the desired channel. Next, press, (or press and hold), the assigned **PF** key. The display will indicate “**FM SCAN**”.

---

## ADVANCED OPERATION

---

### SCAN SET

Scan Set enables the user to add or delete a current channel to a pre-programmed scan list.

When store a particular channel to your scanning list, the display indicates “**SCN SET**” briefly. When delete a channel from your scanning list, the display indicates “**SCN SKIP**” briefly.

When the scanner is paused, you may remove the channel from the scan list temporarily by pressing the assigned **PF** key.

### GROUP SCAN SET

You may wish to have the Scanner pass through more than one Group during the scanning process (normally, scanning is performed within the current group only).

To include the current Group in the scanning loop, press the assigned **PF** key: a small dot (“•”) will appear at the bottom of the display.

To remove a current Group from Group Scan, press the assigned **PF** key again, a small dot (“•”) will disappear from the display.

### TA (TALK AROUND) SCAN

Toggle the TA Scan feature “On” and “Off”.

When operating on a duplex channel system (for example, a repeater station), TA Scan allows the transceiver to search both transmit and receive frequencies on your duplex system.

When a signal is encountered on the receive frequency, the transceiver will pause until the signal disappears. When a signal is encountered on the transmit frequency, the transceiver will check for activity on the receive frequency every few seconds (interval programmed by your Motorola Solutions dealer).

When the TA Scan feature is activated, the “” icon will blink on the display.

*Note:* The TA Scan feature does not activate on a Simplex Channel.

### TALK AROUND

Talk Around is most commonly utilized when operating on duplex channel systems (separate receive and transmit frequencies, common with use of a repeater station). The Talk Around feature allows you to bypass the repeater station and talk directly to a nearby station or transceiver. This feature has no effect when you are operating on “simplex” channels, where the receive and transmit frequencies are already the same.

When the Talk Around feature is activated, the “” icon will be indicated on the display.

---

## ADVANCED OPERATION

---

Note that your dealer may have mode provision for “Talk Around” channels by programming “repeater” and “Talk Around” frequencies on two adjacent channels. If so, the key may be used for one of the other Pre-Programmed Functions.

### **SEARCH**

Identify the signal of the closest site (station) with the strongest signal strength (RSSI) and then connect to that site (station) automatically.

Site Search enables the radio to move between multiple sites seamlessly by identifying the strongest, closest site signal. The radio will dynamically change its pre-programmed home site to the site with the strongest signal in range when Site Search is activated.

**Note:** This feature may be possibly assigned to the channel by your administrator or Motorola Solutions dealer.

### **RESET**

When operating in the selective call feature, press the assigned **PF** key to terminate the communication by the selective call function.

### **CODE UP/DOWN**

Select a 2-Tone, 5-Tone, or DTMF encode code from the pre-programmed encode list. Press the **PTT** switch to send a selected code.

### **SPEED DIAL**

Your Motorola Solutions dealer may have pre-programmed Auto-Dial telephone number memories into your radio.

To dial a number:

- Press the assigned **PF** key. The “Tag” name corresponding with the current Auto-Dial memory will appear on the display.
- Press the [**▼**]/[**▲**] keys to select the Auto-Dial memory you wish to dial.
- Press the **PTT** switch to send a pre-defined DTMF tone. The DTMF tones sent during the dialing sequence will be heard in the speaker.

### **CALL**

The Call feature is different for each type of the signaling system:

#### **WHEN USING THE 2-TONE/5-TONE SIGNALING SYSTEM**

Send a pre-programmed 2-Tone/5-Tone Call Signal with an one touch **PF** key.

#### **WHEN USING THE MDC1200 SYSTEM**

---

## ADVANCED OPERATION

---

Confirm the Contact Alias of the MDC1200® Signaling feature, and you may perform the following operation to that Contact Alias. Available operations are “Call Alert”, “Sel Call”, “Radio Check”, “Revive”, and “Stun”.

### Call Alert

You may transmit the Call Alert to the selected Contact Alias.

- ❑ Press the assigned **PF** key to activate the MDC1200 Call feature.
- ❑ Press the [▼]/[▲] keys to recall the Contact Alias you wish to contact, then press the [MODE(☎)] key.
- ❑ Press the [▼]/[▲] keys to select “CALL ALT”.
- ❑ Press the [MODE(☎)] key to transmit the Call Alert command to the designated radio. If the designated radio is active, the designated radio transmits the ACK command and displays your ID number on the display.

### Sel Call

You may call the selected Contact Alias.

- ❑ Press the assigned **PF** key to activate the MDC1200 Call feature.
- ❑ Press the [▼]/[▲] keys to recall the Contact Alias you wish to contact, then press the [MODE(☎)] key.
- ❑ Press the [▼]/[▲] keys to select “SEL CALL”.

- ❑ Press the [MODE(☎)] key to transmit the Selective Call command to the designated radio. If the designated radio is active, the designated radio transmits the ACK command and displays your ID number on the display.

### Radio Check

You may check the radio status of the selected Contact Alias.

- ❑ Press the assigned **PF** key to activate the MDC1200 Call feature.
- ❑ Press the [▼]/[▲] keys to recall the Contact Alias you wish to contact, then press the [MODE(☎)] key.
- ❑ Press the [▼]/[▲] keys to select “RADIO CK”.
- ❑ Press the [MODE(☎)] key to transmit the Radio Status command to the designated radio (the display will indicate “-CAL IN-”). If the designated radio is “alive”, or in range and powered on, the designated radio transmits the ACK command, and then your radio’s display indicates “ACK RECV”. If not, your radio’s display indicates “-NO ACK-”.

### Revive

You may revive the stunned radio by following the listed steps.

- ❑ Press the assigned **PF** key to activate the MDC1200 Call feature.

---

## ADVANCED OPERATION

---

- ❑ Press the [▼]/[▲] keys to recall the Contact Alias you wish to revive, then press the [MODE(On)] key.
- ❑ Press the [▼]/[▲] keys to select “REVIVE”.
- ❑ Press the [MODE(On)] key to transmit the revive command to the stunned radio (the display will indicate “-CAL IN-”). When the stunned radio receives the revive command, the stunned radio revives, and then transmits the ACK command automatically. Your radio’s display indicates “ACK RECV”. If your radio’s display indicates “-NO ACK-”, the revive command did not succeed.

### Stun

You may stun a selected radio in your fleet (temporarily disable from transmitting/receiving) forcibly by remote control.

- ❑ Press the assigned PF key to activate the MDC1200 Call feature.
- ❑ Press the [▼]/[▲] keys to recall the Contact Alias you wish to stun, then press the [MODE(On)] key.
- ❑ Press the [▼]/[▲] keys to select “STUN”.
- ❑ Press the [MODE(On)] key to transmit the stun command to the designated radio (the display will indicate “-CAL IN-”). If the designated radio is alive, the designated radio transmits the ACK command and stuns it. If not, your radio’s display indicates “-NO ACK-”, the disabling command did not succeed.

The Stunned radio will revive by the “Revive” function described previously.

### WHEN OPERATING IN THE DIGITAL MODE

- ❑ Press the assigned PF key to activate the Call feature.
- ❑ Press the [▼]/[▲] keys to select the Contact Alias.
  - If the TX ID Type of the selected Contact Alias is “Group Call” or “All Call” (indicates the “G” or “A” icon on the display), press the [MODE(On)] key twice to display the ID code of the selected Contact Alias.
  - If the TX ID type of the selected Contact Alias is “Individual Call” (indicates “I” icon on the display), you may perform the “Call Alert”, View ID, “Radio Check”, “Revive”, or “Stun” operation.

### Call Alert

You may call the selected Contact Alias.

- ❑ Press the assigned PF key to activate the Call feature.
- ❑ Press the [▼]/[▲] keys to recall the Contact Alias you wish to contact, then press the [MODE(On)] key.
- ❑ Press the [▼]/[▲] keys to select “CALL ALT”.
- ❑ Press the [MODE(On)] key to transmit the Call Alert command to the designated radio. If the designated radio is active, the designated radio transmits the ACK command and displays your ID number on the display. If not, your radio’s display indicates “-NO ACK-”.

---

## ADVANCED OPERATION

---

### View ID

You may confirm the ID code of the selected Contact Alias.

- Press the assigned **PF** key to activate the Call feature.
- Press the [▼]/[▲] keys to recall the Contact Alias you wish to confirm the ID code, then press the [MODE(☉)] key.
- Press the [▼]/[▲] keys to select “VIEW ID”.
- Press the [MODE(☉)] key to display the ID code of the selected Contact Alias.

### Radio Check

You may check the radio status of the selected Contact Alias.

- Press the assigned **PF** key to activate the Call feature.
- Press the [▼]/[▲] keys to recall the Contact Alias you wish to check, then press the [MODE(☉)] key.
- Press the [▼]/[▲] keys to select “RADIO CK”.
- Press the [MODE(☉)] key to transmit the Radio Status command to the designated radio. If the designated radio is alive, the designated radio transmits the ACK command, and then your radio’s display indicates “ACK RECV”. If not, your radio’s display indicates “-NO ACK-”.

### Revive

You may revive the stunned radio by following the listed steps.

- Press the assigned **PF** key to activate the Call feature.
- Press the [▼]/[▲] keys to recall the Contact Alias you wish to revive, then press the [MODE(☉)] key.
- Press the [▼]/[▲] keys to select “REVIVE”.
- Press the [MODE(☉)] key to transmit the revive command to the disabled radio. When the stunned radio receives the revive command, the stunned radio revives, and then transmits the ACK command automatically. Your radio’s display indicates “ACK RECV”. If your radio’s display indicates “-NO ACK-”, the revive command did not succeed.

### Stun

You may stun a selected radio in your fleet (temporarily disable from transmitting/receiving) forcibly by remote control.

- Press the assigned **PF** key to activate the Call feature.
- Press the [▼]/[▲] keys to recall the Contact Alias you wish to stun, then press the [MODE(☉)] key.
- Press the [▼]/[▲] keys to select “STUN”.
- Press the [MODE(☉)] key to transmit the stun command to the designated radio. If the designated radio is alive, the designated radio transmits the ACK command and stuns it. If not, your radio’s display indicates “-NO ACK-”, the disabling command did not succeed.

The stunned radio will revive by the “Revive” function described previously.

---

## ADVANCED OPERATION

---

### STATUS UP/DOWN

You may send the 5-Tone status code to other radio.

Select a 5-Tone status code from the pre-defined status list, then press the **PTT** button to send the selected status code.

### STATUS CHECK

Check the 5-Tone receive status code. When you press the assigned **PF** key, the display will indicate the “Message” corresponding to the receive status condition per the pre-defined status list.

### DUTY

The Duty function is specific to paging operation. When Duty mode is “ON” the user will hear all traffic (specific to sub audio signaling) on the paging channel. The paging alert will sound when the programmed 2-Tone or 5-Tone sub audio signal is received.

If Duty mode is “OFF”, normal radio traffic is not heard on the paging channel. The radio will only unmute and sound the paging alert with the programmed 2-Tone or 5-Tone signal is received.

### ID CHECK

This function allows you to confirm the logged ID of the operating system which set to the current operating channel. Available operating system are 5-Tone ID, DTMF ID,

MDC1200® ID, and Digital ID.

- Press the assigned **PF** key to display the logged ID.
- Press the [**▼**]/[**▲**] keys to select the logged ID.
- Press and hold in the [**SIDE**] key to toggle the display between the “ID Code display” and “Channel Tag display”.
- Press the [**SIDE**] key to revert to the normal channel indication.

### TEXT MESSAGE

You may receive/send the message from/to other radio. See page 37 for more information of the message feature.

### REMOTE HALT TX (TX INTERRUPT REMOTE DEKEY)

This feature allows a priority user (assigned with the programming software) the ability to halt or “interrupt” any current transmission. The channel is then open for a priority message to be sent. Transmit Interrupt functionality ensures connection of critical messages.

Press the assigned **PF** key to halt any current transmission. The channel will clear, then press the **PTT** button to transmit the priority message.

---

## ADVANCED OPERATION

---

### **TX SAVE DISABLE** (TRANSMIT BATTERY SAVER DISABLE)

The Transmit Battery Saver helps extend battery life by reducing transmit power when a very strong signal from a nearby station is being received. Caution is advised when using this feature, as your transmission power could degrade the audio heard by the receiving radios in your communication path.

Disabling the Transmit Battery saver by pressing the **PF** key is recommended if you are operating in a location where high power is almost always required.

Press again the assigned **PF** key, the Transmit Battery Saver activates to reduce the transmit power when a very strong signal from an apparently nearby station is being received.

### **LOCK**

The Programmable keys and **PTT** switch can be activated/deactivated by an assigned **PF** key.

You may change the lockout configuration by the “User Set (Menu)” mode. See page 36 for more information.



## USER SET (MENU) MODE

The “User Set” (Menu) Mode allows the user to define or configure various settings, such as Squelch, Key lockout configuration, etc. The basic operation method of the “User Set” (Menu) Mode is as follows:

- Press the **[MODE(On)]** key to enter the “User Set” (Menu) Mode.
- Select the Set Mode item you wish to change using the **[▼]/[▲]** keys, then press the **[MODE(On)]** key.
- Adjust the setting of the selected item using the **[▼]/[▲]** keys.
- You may revert to the previous step by pressing the **[SIDE]** key.
- Press the **[MODE(On)]** key to save the new setting and exits to normal operation.  
You may exit to normal operation without saving the new setting by press and holding the **[MODE(On)]** key.

The possible setting features are listed at the right box, and their operations are explained from next page. In this chapter, the following icons are used to indicate item (or feature) supported in either the “Analog” mode or “Digital” mode:

**[A]**: Indicates an “Analog” mode only feature.

**[D]**: Indicates a “Digital” mode only feature.

For item (or feature) that are available in both “Analog” and “Digital” modes, no icon is shown.

There is function which is not called depending on the state of the operating channel when entering the User Set (Menu) Mode.

For example, if you are operating in a “Digital” channel, the SQL SET function has not been recalled.

<b>LIST</b>
Digital Contact List
5-Tone Code Select
2-Tone Code Select
DTMF Code Select
MDC1200 ID Select
<b>Group</b>
<b>Scan</b>
<b>Utility</b>
Monitor
SQL OFF
Power
Minimum Volume Level
Beep
Beep Level
SQL Level
Lighting
ENCR
Privacy Select
Lone Worker
Bell
PRI-2
VOX
VOX Anti-Trip
VOX Level
TA
Scan Set/Skip
Group Scan Set/Skip
Duty
TX Save Disable
Lock Key
Lock PTT
<b>DIAL</b>
<b>Message</b>
<b>History</b>
<b>LOCK</b>

---

## USER SET (MENU) MODE

---

### LIST

In this item, you may operate the following functions:

- Digital Contact List
- 5-Tone Code Select
- 2-Tone Code Select
- DTMF Code Select
- MDC1200 ID Select

Press the [▼]/[▲] keys to recall the function you wish to operate, then press the [MODE(On)] key to activate them. Refer to follows for detailed operation of each function.

#### DIGITAL CONTACT LIST

Digital Contact List allows you to confirm the Contact Alias on the Digital mode by pressing the [▼]/[▲] keys.

If the TX ID Type of the selected Contact Alias is “Group Call” or “All Call” (indicates the “G” or “A” icon on the display), you may confirm the ID code of the selected Contact Alias.

If the TX ID type of the selected Contact Alias is “Individual Call” (indicates “I” icon on the display), you may perform the “Call Alert”, View ID, “Radio Check”, “Revive”, or “Stun” operation. See page 27 for detail of the Digital Call operation.

#### 5-TONE CODE SELECT

5-Tone Code Select allows you to select/send the 5-Tone encode code of the pre-programmed encoder list.

Press the [▼]/[▲] keys to select the 5-Tone encode code, and then press the [MODE(On)] key to transmit the selected 5-Tone encode code.

#### 2-TONE CODE SELECT

2-Tone Code Select allows you to select/send the 2-Tone encode code of the pre-programmed encoder list.

Press the [▼]/[▲] keys to select the 2-Tone encode code, and then press the [MODE(On)] key to transmit the selected 2-Tone encode code.

#### DTMF CODE SELECT

DTMF Code Select allows you to select/send the DTMF Page code of the pre-programmed encoder list.

Press the [▼]/[▲] keys to select the DTMF Page code, and then press the [MODE(On)] key to transmit the selected DTMF Page code.

#### MDC1200 ID SELECT

MDC1200 ID Select allows you to select the Contact Alias on the MDC1200® Signaling feature by pressing the [▼]/[▲] keys, and you may perform “Call Alert”, “Sel Call”, “Radio Check”, “Revive”, and “Stun” operation. See page 25 for detail of the MDC1200 Call operation.

---

## USER SET (MENU) MODE

---

### GROUP

You may select a different group of channels.

- Press the [▼]/[▲] keys to recall the desired group. A group number will appear at the upper right corner and a group name will appear briefly on the display.
- Press the [MODE(↻)] key to accept the group.

### SCAN

In this item, you may activate/deactivate the Scan function. Available selections are:

- OFF:** Stop the scan operation of the currently running.
- Scan:** Stop the scan operation of the currently running (if activated), and then start the Scan operation. See page 22 for detail of the Scan operation.
- Group Scan:** Stop the scan operation of the currently running (if activated), and then start the Group Scan operation. See page 23 for detail of the Group Scan operation.
- FM Scan:** Stop the scan operation of the currently running (if activated), and then start the FM (Follow Me) Scan operation. See page 23 for detail of the Follow Me Scan operation.
- Dual Watch:** Stop the scan operation of the currently running (if activated), and then start the Dual Watch operation. See page 23 for detail of the Dual Watch operation.
- TA Scan:** Stop the scan operation of the currently running (if activated), and then start the TA (Talk Around) Scan operation. See page 24 for detail of the TA Scan operation.

---

## USER SET (MENU) MODE

---

### UTILITY

In this item, you may operate the following functions:

- Monitor
- SQL OFF
- Power
- Minimum Volume Level
- Beep
- Beep Level
- SQL Level
- Lighting
- ENCR (Privacy/Encryption)
- Privacy Select
- Lone Worker
- Bell
- PRI-2
- VOX
- VOX Anti-Trip
- VOX Level
- TA
- Scan Set/Skip
- Group Scan Set/Skip
- Duty
- TX Save Disable (Transmit Battery Saver Disable)
- Lock Key
- Lock PTT

Press the [▼]/[▲] keys to recall the function you wish to operate, then press the [MODE(On)] key to activate them. Refer to follows for detailed operation of each function.

### MONITOR

You may toggle the any signaling feature “On” and “Off” by pressing the [▼]/[▲] keys.

### SQL OFF

You may toggle the squelch circuit “On” and “Off” by pressing the [▼]/[▲] keys.

### POWER

You may toggle the radio’s transmit power “High” and “Low” by pressing the [▼]/[▲] keys.

### MINIMUM VOLUME LEVEL

You may set the audio volume level when activating the AF Min Volume function by pressing the [▼]/[▲] keys. Available selections are “0” ~ “255”.

### BEEP

You may toggle the radio beeps “On” and “Off” by pressing the [▼]/[▲] keys.

### BEEP LEVEL

You may set the radio beep level by pressing the [▼]/[▲] keys. Available selections are “0” ~ “15”.

### SQL LEVEL

You may select the squelch level by pressing the [▼]/[▲] keys. Available selections are “SQLLV OP (Open)”, “SQLLV TH (Threshold)”, “SQLLV NM (Normal)” and “SQLLV TI (Tight)”.

---

## USER SET (MENU) MODE

---

### LIGHTING

You may toggle the back light of the display and keypad “On” and “Off” by pressing the [▼]/[▲] keys.

### ENCR (PRIVACY / ENCRYPTION

You may toggle the Digital Privacy feature or Analog Voice Inversion Encryption feature “On” and “Off” by pressing the [▼]/[▲] keys.

### PRIVACY SELECT

You may select the Privacy Code for the Privacy feature by pressing the [▼]/[▲] keys. Available selections are “1” ~ “16”.

### LONE WORKER

You may toggle the Lone Worker feature “On” and “Off” by pressing the [▼]/[▲] keys.

### BELL

You may select the CTCSS/DCS Bell function “On” or “Off” by pressing the [▼]/[▲] keys.

When the CTCSS/DCS Bell function is set to “On”, the alert tone activates when receive the signal including a CTCSS or DCS tone which matches that set into your radio.

### PRI-2

You may enable/disable to set the current operating channel to the Priority Channel of the current group (Priority-2 Channel) by pressing the [▼]/[▲] keys.

### VOX

You may toggle the VOX function “On” and “Off” by pressing the [▼]/[▲] keys.

### VOX ANTI-TRIP

You may toggle the VOX Anti-Trip feature “On” and “Off” by pressing the [▼]/[▲] keys.

### VOX LEVEL

You may adjust the VOX Gain by pressing the [▼]/[▲] keys. Available selections are “-8” ~ “+8”.

### TA

You may toggle the Talk Around feature “On” and “Off” by pressing the [▼]/[▲] keys. See page 24 for detail of the Talk Around feature.

### SCAN SET/SKIP

You may add/delete the current channel to/from your scanning list by pressing the [▼]/[▲] keys.

### GROUP SCAN SET/SKIP

You may add/delete the current group to/from your scanning process by pressing the [▼]/[▲] keys.

### DUTY

You may toggle the Duty function “On” and “Off” by pressing the [▼]/[▲] keys. See page 29 for detail of the Duty function.

---

---

## USER SET (MENU) MODE

---

---

### **TX SAVE DISABLE (TRANSMIT BATTERY SAVER DISABLE)**

You may activate/deactivate the Transmit Battery Saver Disable function by pressing the [▼]/[▲] keys. See page 30 for detail of the Transmit Battery Saver Disable function.

### **LOCK KEY**

You may enable/disable the Programmable Function Keys by the Key Lock function. Available Values:

**LOCK:** The Programmable Function Keys will be locked by the Key Lock function.

**FREE:** The Programmable Function Keys will not be locked by the Key Lock function.

### **Lock PTT**

You may enable/disable the **PTT** switch by the Key Lock function. Available Values:

**LOCK:** The **PTT** switch will be locked by the Key Lock function.

**FREE:** The **PTT** switch will not be locked by the Key Lock function.

### **DIAL**

In this item, you may dial the DTMF Auto-Dial telephone number which was pre-programmed.

- Press the [▼]/[▲] keys to select the DTMF Auto-Dial telephone number you wish to dial.
- Press the **PTT** switch to send a pre-defined DTMF tone, and the DTMF tones sent during the dialing sequence will be heard in the speaker.

---

## USER SET (MENU) MODE

---

### MESSAGE

The Message feature is different by the operating system. Refer to follows for detailed operation of each operating system.

#### DIGITAL MODE

Message feature on the “Digital” mode, you may receive/send the text message from/to other radio.

- Press the [▼]/[▲] keys to select either of the functions “INBOX” and “SEL MSG” which you want to.  
**INBOX:** Confirm/delete the received text message.  
**SEL MSG:** Send the text message to other radio.
- Press the [MODE()] key to accept the selected function. Refer to follows for detailed operation of each function.

#### “INBOX” function

In this function, you may confirm/delete the received text message.

- Press the [▼]/[▲] keys to select “INBOX”, then press the [MODE()] key to accept it.
- Press the [▼]/[▲] keys to select the received text message. The **EVX-S24** can memorize up to 20 messages (first-in first-out basis). You may find the “**ALL Delete**” selection which is located at the last message loop. Describes details of this selection in the next paragraph.



- Press and hold in the [SIDE] key to confirm the “Call ID” of the selected message.
- If you want to delete the selected message:
  - Press and hold in the [SIDE] key again to indicate the “**Delete**” selection.
  - Press the [▼]/[▲] keys to select the “**Yes**”, then press the [MODE()] key.
  - You may cancel the deleting the message by selecting the “**No**” instead “**Yes**” in the above step.

**ALL Delete:** You may delete the all text messages at once.

- Press the [▼]/[▲] keys to select the “**ALL Delete**” selection which is located at the last message loop.
- Press the [▼]/[▲] keys to select the “**Yes**”, then press the [MODE()] key.
- You may cancel the deleting the all text messages by selecting the “**No**” instead “**Yes**” in the above step.

#### “SEL MSG” function

In this function, you may send the text message to other radio.

- Press the [▼]/[▲] keys to select “**SEL MSG**”, then press the [MODE()] key to accept it.
- Press the [▼]/[▲] keys to select the message you wish to send.
- Press the [MODE()] key, “**SEND**” notation will appear.

---

## USER SET (MENU) MODE

---

- Press the [MODE(OM)] key, then press the [▼]/[▲] keys to select the Contact Alias.
- Press the [MODE(OM)] key again to send the message.

### ANALOG MODE A

Message feature on the “Analog” mode, you may send the 5-Tone status text of the pre-programmed encoder list, and confirm the “Message” corresponding to that received 5-Tone status text.

#### Sending the Message

- Press the [▼]/[▲] keys to select “SELECT”.
- Press the [MODE(OM)] key, then press the [▼]/[▲] keys to select the “Message” you wish to send.
- Press the **PTT** key to send the message.

#### Confirm the Message

- Press the [▼]/[▲] keys to select “CHECK”.
- Press the [MODE(OM)] key to appear the received “Message”.

### HISTORY

In this item, you may confirm the history of the received station’s ID of the operating system which set to the current operating channel. Available operating system are Digital ID, 5-Tone ID, DTMF ID, and MDC1200® ID.

- Press the [▼]/[▲] keys to scroll the received station’s ID of the operating system which set to the current operating channel.
- Press and hold in the [SIDE] key to indicate the “Channel Tag (Name)” which received that station’s ID, if desired.

### LOCK

In this item, you may lock the Programmable keys and **PTT** switch to prevent accidental channel change or inadvertent transmission.

To locked out the key locking, press and hold the [MODE(OM)] key.

You may change the lockout configuration by the “Lock Key” and “Lock PTT” functions in the “Utility” item of this “User Set (Menu)” mode. See page 36 for more information.



---

---

## OPTIONAL ACCESSORIES

---

---

<b>BT100x</b>	3.7V DC  , 2300 mAh Li-Ion Battery Pack
<b>CD-65</b>	Charger Stand (requires the Power Supply Adapter)
<b>CD-66</b>	Dual Battery Single Unit Charger (requires the Power Supply Adapter)
<b>PS000042AXX*</b>	Power Supply Adapter, AC/DC, Switch Mode, 5W, 100 V- 240 V, Micro-USB
<b>MH-89A4B</b>	Earpiece Microphone
<b>VH-190</b>	Behind-the-Head VOX-Compatible Headset
<b>ATU-6A</b>	UHF Antenna (400-430 MHz)
<b>ATU-6B</b>	UHF Antenna (420-450 MHz)
<b>ATU-6C</b>	UHF Antenna (440-470 MHz)
<b>ATU-6D</b>	UHF Antenna (450-485 MHz)
<b>ATU-20AS</b>	UHF Stubby Antenna (400-430 MHz)
<b>ATU-20CS</b>	UHF Stubby Antenna (420-450 MHz)
<b>ATU-20DS</b>	UHF Stubby Antenna (440-470 MHz)
<b>ATU-20FS</b>	UHF Stubby Antenna (450-480 MHz)
<b>CLIP-27</b>	Belt Clip
<b>CE157</b>	PC Programming Software
<b>CB000262A01</b>	Micro USB Programming Cable

**XX\***: “11” suffix is for USA

“12” suffix is for EU

“13” suffix is for UK

“15” suffix is for Argentina

“16” suffix is for China

“14” suffix is for Australia

“18” suffix is for Brazil

- Always use Motorola Solutions authorized accessories. Motorola Solutions shall not be liable for any damage or accidents such as fire, leakage or explosion batteries, etc., caused by the malfunction of non-Motorola Solutions accessories.*
- Availability of accessories may vary; some accessories are supplied standard per local requirements, others may be unavailable in some regions. Check with your Motorola Solutions Dealer for changes to this list.*

---

---

## **WARRANTY POLICY**

---

---

Motorola Solutions warrants, to the original purchaser only, its Motorola Solutions manufactured communications products against defects in materials and workmanship under normal use and service for a given period of time from the date of purchase.

Limited Warranty Details:

Contact the authorized Motorola Solutions distributor in your country.

The AMBE+2™ voice coding Technology embodied in this product is protected by intellectual property rights including patent rights, copyrights and trade secrets of Digital Voice Systems, Inc. This voice coding Technology is licensed solely for use within this Communications Equipment. The user of this Technology is explicitly prohibited from attempting to decompile, reverse engineer, or disassemble the Object Code, or in any other way convert the Object Code into a human-readable form.

U.S. Pat. Nos. #5,870,405, #5,826,222, #5,754,974, #5,701,390, #5,715,365, #5,649,050, #5,630,011, #5,581,656, #5,517,511, #5,491,772, #5,247,579, #5,226,084 and #5,195,166.

#### **DISPOSAL OF YOUR ELECTRONIC AND ELECTRIC EQUIPMENT**

Products with the symbol (crossed-out wheeled bin) cannot be disposed as household waste.

Electronic and Electric Equipment should be recycled at a facility capable of handling these items and their waste by products.

In EU countries, please contact your local equipment supplier representative or service center for information about the waste collection system in your country.



Part 15.21: Changes or modifications to this device not expressly approved by Motorola Solutions could void the user's authorization to operate this device.



No portion of this manual may be reproduced without the permission of Motorola Solutions, Inc.

MOTOROLA, MOTO, MOTOROLA SOLUTIONS and Stylized M logo are trademarks or registered trademarks of Motorola Trademark Holdings, LLC and are used under license..

All other trademarks are the property of their respective owners.

©2017 Motorola Solutions, Inc.

All rights reserved.

**Motorola Solutions, Inc.**

500 W. Monroe Street Chicago, IL 60661 USA

